

PHOS PROJECTORS 2018



derksen®
lichttechnik



Communication Through Light

Unique Image Projections Made in Germany

Electric light is a medium that can carry a message. A means of communication. Lighthouses inform about the course of the coastline. Light beams can transport the Morse code over long distances. With the fingers of the hand, held in front of a lamp, imaginative shadow plays can be invented. It's only a small step from practical illumination to creative and communicative lighting design.

A place, an idea, a statement. Artists like Markus Brenner, Detlef Hartung and Georg Trenz use light projections to present their works in the context of monuments and important places. In front of the main portal of the Cologne Cathedral, the archbishop reminds us of the year of the Holy Door with luminous texts in numerous languages. The Paderborn Heinz-Nixdorf MuseumsForum informs visitors on a journey through IT history with QR codes projected onto the floor. A virtual arrow, projected onto the floor, guides customers as they make their way through the warehouse.

With projection systems from Derksen, texts, graphics, brand logos and photorealistic images can be projected onto any suitable surface. The product spectrum ranges from compact projectors for indoor use to high-performance, weatherproof outdoor systems. Development and production in highest quality standards happens in Germany without exception. Consultation and service all around your individual needs are matter of course.

The possibilities of communication seem limitless. It depends on your vision – so let yourself be inspired on the following pages.

PHOS LED PROJECTORS

No other light source can match the efficiency of an LED, the acronym for Light Emitting Diode. An LED generates light without UV and infra-red radiation. It also guarantees durability of up to 35,000 operating hours (L 70) by low energy consumption and a compact style. You can quickly recoup the initial expenses.

PHOS projectors generate less heat and can be used absolutely noiselessly without ventilation. Immediately after being switched on the light is emitted in full intensity. The projections have the distinction of an extraordinary sharpness and an even distribution of brightness which is the result of precise emission without an additional reflector.

This brochure provides an overview of our standard products. Projection technology by Derksen is also employed in numerous custom solutions. For example, under specific environmental conditions such as car washes or projecting safety signs in industrial facilities and warehouses to prevent risks.



environmentally friendly, conserves natural resources



noiseless, low heat emission



low energy consumption, high light-yield



mercury-free, easily recyclable



35,000 hours lamp life (L70), low maintenance

PHOS 15		6
PHOS 25 – 85		10
PHOS 15 LT		16
PHOS 25 – 85 LT		18
PHOS 25 – 85 downlight		22
PHOS 25 – 85 outdoor		26
PHOS 25 – 85 pole mount		32
PHOS 45 – 85 move		36
PHOS 45 – 85 rotator		40

PHOS 15

Compact LED Projector with Great Impact

The smallest LED projector in our product range is PHOS 15. Its performance will astonish you with its recommended range of up to 6 meters (20 ft.) in normal room lighting. The device is suitable for dry indoor environments and can optionally be mounted on tabletops, shelves, ceilings or walls. Its compact size makes it easy to install the PHOS 15 without attracting attention, but projecting a surprising outcome. Possible locations include bars, lounges, shop windows

or rack structures. The projection motif can be changed without tools. Due to Derksen's quick installation system, the projected image can be rotated and focused easily in a single operation.



- 1 – projection lens
- 2 – interchangeable motif (gobo)
- 3 – high power LED
- 4 – heat sink
- 5 – LED driver
- 6 – mounting plate

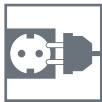

PHOS 15

output power:	15 W 1,200 lumens
recommended range:	2 – 4 m 6.6 – 13 ft
projection lens:	85 mm standard, non-interchangeable
LED lifetime (L70):	35,000 hours
cooling:	passive – 0 dBA
weight:	1.9 kg 4.2 lbs
dimensions (w x h x d):	212 x 222 x 165 mm 8.35 x 8.74 x 6.50 inches

item number:	20015110 – white 20015120 – black 20015130 – silver
	618.80 € 520.00 €

net price incl. 19% German VAT
excl. 19% German VAT

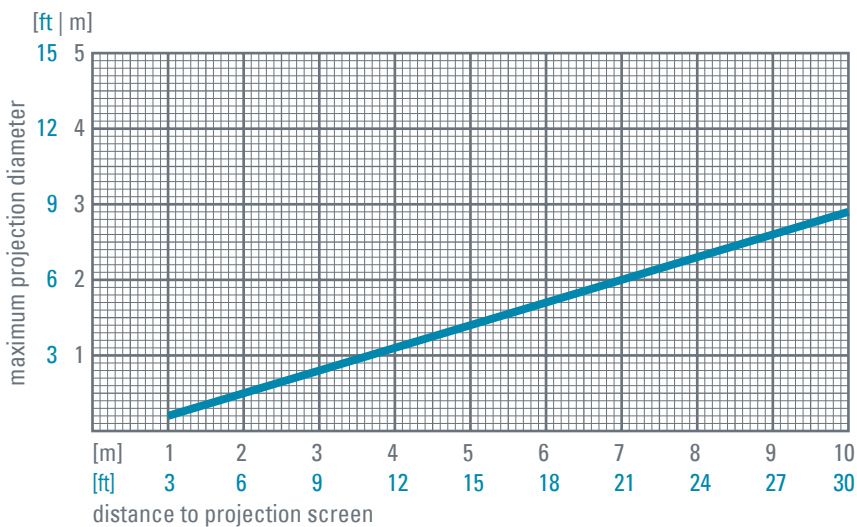

We reserve the right to make technical and optical modifications. Our general terms and conditions apply.
All prices are the manufacturer's recommended retail prices (RRP) and can be subject to change without prior notification.





FEJKA
2.99

1.99

PHOS 25 – 85

Versatile Indoor Projection Systems

PHOS 25-85 indoor projectors are equipped with the latest LED technology. Despite its compact design, they deliver superior brightness. Except PHOS 25, all systems are actively cooled by an almost noiseless fan.

The devices are suitable for dry indoor environments and can optionally be mounted on tabletops, shelves, ceilings or walls. PHOS 25 – 85 systems are recommended for loca-

tions such as: entrance halls, sales rooms, banks, trade fair booths and museums. The projection motif (gobo) can be changed without tools. Due to Derksen's quick installation system, the projected image can be rotated and focused easily in a single operation. Several projection lenses with different focal lengths are available.







Christus sitzt im Flüchtlingsboot
Le Christ est dans le bateau des réfugiés
Christ sits in the refugee boat
Jesús también está en la patera
キリストが難民ボートに
基督与难民同舟共济。
Cristo está sentado na barca dos refugiados
المسيح جالس في قارب اللاجئين
Chrystus jest z uchodźcami w łodzi
Христос в лодке с беженцами

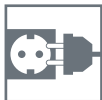

output power:
recommended range:
LED lifetime (L70):
cooling:
weight:
dimensions (w x h x d):

item number:

PHOS 25

22 W | 1,800 lumens
2 – 6 m | 6.6 – 20 ft
35,000 hours
passive – 0 dBA
3.65 kg | 8.0 lbs
270 x 266 x 193 mm
10.63 x 10.47 x 7.60 inches

20025110 – white
20025120 – black
20025130 – silver
856.80 € | 720.00 €

PHOS 65

output power:
recommended range:
LED lifetime (L70):
cooling:
weight:
dimensions (w x h x d):

item number:

60 W | 3,800 lumens
4 – 10 m | 13 – 33 ft
35,000 hours
active cooling, fan – 20 dBA
3.9 kg | 8.6 lbs
270 x 266 x 193 mm
10.63 x 10.47 x 7.60 inches

20065110 – white
20065120 – black
20065130 – silver
1475.60 € | 1240.00 €

PHOS 45

40 W | 2,700 lumens
3 – 8 m | 9.8 – 26 ft
35,000 hours
active cooling, fan – 20 dBA
3.8 kg | 8.4 lbs
270 x 266 x 193 mm
10.63 x 10.47 x 7.60 inches

20045110 – white
20045120 – black
20045130 – silver
1184.10 € | 995.00 €

PHOS 85

80 W | 5,750 lumens
5 – 15 m | 16 – 49 ft
35,000 hours
active cooling, fan – 20 dBA
3.9 kg | 8.6 lbs
270 x 266 x 193 mm
10.63 x 10.47 x 7.60 inches

20085110 – white
20085120 – black
20085130 – silver
1642.20 € | 1380.00 €

net price incl. 19% German VAT | excl. 19% German VAT





PHOS 15 LT

Compact Projector for Lighting Tracks

PHOS 15 LT is equipped with an adapter for 3-phase standard lighting tracks. By the way, the "LT" in the product name is an acronym for "Lighting Track". Performance and specifications correspond to the standard version PHOS 15.

PHOS 15 LT is the smallest LED projector in our product range. Its performance will astonish you with its recommended range of up to 6 meters (20 ft.) in normal room lighting. Possible locations include bars, lounges, shop windows or salesrooms. The projection

motif can be changed without tools. Due to Derksen's quick installation system, the projected image can be rotated and focused easily in a single operation.

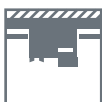

output power:	15 W 1,200 lumens
recommended range:	2 – 4 m 6.6 – 13 ft
projection lens:	85 mm standard, non-interchangeable
LED lifetime (L70):	35,000 hours
cooling:	passive – 0 dBA
weight:	1.9 kg 4.2 lbs
dimensions (w x h x d):	212 x 252 x 156 mm 8.35 x 9.92 x 6.14 inches

item number:	20015210 – white 20015210 – black 20015210 – silver
--------------	-----------------------------------------------------------

PHOS 15 LT

618.80 € | 520.00 €

net price incl. 19% German VAT
excl. 19% German VAT

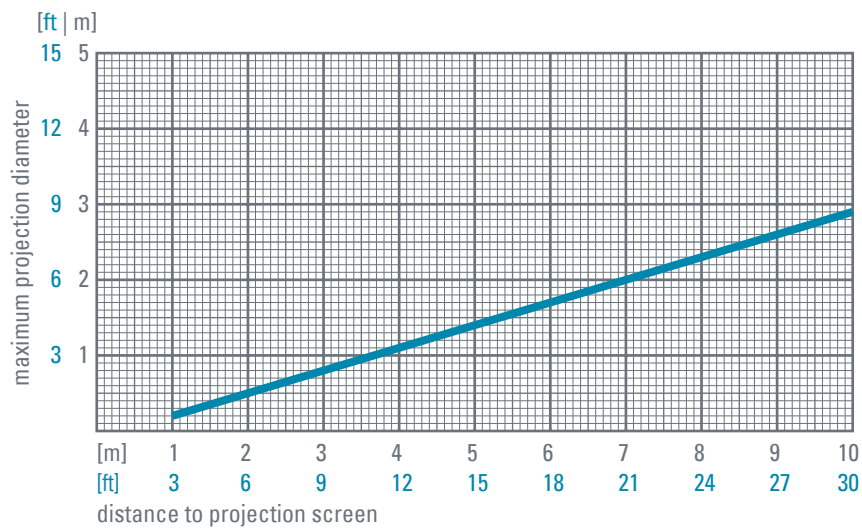

We reserve the right to make technical and optical modifications. Our general terms and conditions apply.
 All prices are the manufacturer's recommended retail prices (RRP) and can be subject to change without prior notification.



PHOS 25 – 85 LT

Stylish Projector for Lighting Tracks

PHOS 25 – 85 LT can easily be attached to any existing 3-phase track lighting system. There is no need for any additional fixtures and mounting options. The projectors are equipped with the latest LED technology. Despite its compact design, they deliver superior brightness. Except PHOS 25 LT, all systems are actively cooled by an almost noiseless fan.

PHOS LT projectors are particularly suitable for use in museums, sales rooms, shop windows and everywhere else, where lighting tracks are already installed. The projection motif can be changed without tools. Due to Derksen's quick installation system, the projected image can be rotated and focused easily in a single operation. Several projection lenses with different focal lengths are available.



output power:
recommended range:
LED lifetime (L70):
cooling:
weight:
dimensions (w x h x d):

item number:

PHOS 25 LT

22 W | 1,800 lumens
2 – 6 m | 6.6 – 20 ft
35,000 hours
passive – 0 dBA
3.65 kg | 8.0 lbs
270 x 294 x 183 mm
10.63 x 11.57 x 7.20 inches

20025210 – white
20025220 – black
20025230 – silver
856.80 € | 720.00 €

PHOS 65 LT

output power:
recommended range:
LED lifetime (L70):
cooling:
weight:
dimensions (w x h x d):

item number:

60 W | 3,800 lumens
4 – 10 m | 13 – 33 ft
35,000 hours
active cooling, fan – 20 dBA
3.9 kg | 8.6 lbs
270 x 294 x 183 mm
10.63 x 11.57 x 7.20 inches

20065210 – white
20065220 – black
20065230 – silver
1475.60 € | 1240.00 €

PHOS 45 LT

40 W | 2,700 lumens
3 – 8 m | 9.8 – 26 ft
35,000 hours
active cooling, fan – 20 dBA
3.8 kg | 8.4 lbs
270 x 294 x 183 mm
10.63 x 11.57 x 7.20 inches

20045210 – white
20045220 – black
20045230 – silver
1184.10 € | 995.00 €

PHOS 85 LT

80 W | 5,750 lumens
5 – 15 m | 16 – 49 ft
35,000 hours
active cooling, fan – 20 dBA
3.9 kg | 8.6 lbs
270 x 294 x 183 mm
10.63 x 11.57 x 7.20 inches

20085210 – white
20085220 – black
20085230 – silver
1642.20 € | 1380,00 €

net price incl. 19% German VAT | excl. 19% German VAT



WICHTIG & GEFÄHRDEND

Für eine Orientierung wenden Sie sich bitte an unser Verkaufsteam

ANPROBE NUR
MIT STURMHAUBE



PHOS 25 – 85 downlight

LED Projectors for Ceiling Installation

Based on the PHOS LED projectors with its award-winning design, Derksen lighting technology has developed a stylish downlight for installation in false ceilings. The most powerful version is equipped with an 80 watt high power LED and an noise-optimized fan for sufficient cooling. The unobtrusive integration and the impressive light output open new ways for the design of ambiances, for example in shops or public buildings.

The included electronic ballast is placed in the false ceiling. The projection motif can be changed without tools. Due to Derksen's quick installation system, the projected image can be rotated and focused easily in a single operation. Several projection lenses with different focal lengths are available.

- 1 – heat sink with fan
- 2 – vertical adjustment
- 3 – claw fastener
- 4 – horizontal adjustment
- 5 – in-ceiling housing
- 6 – projector head

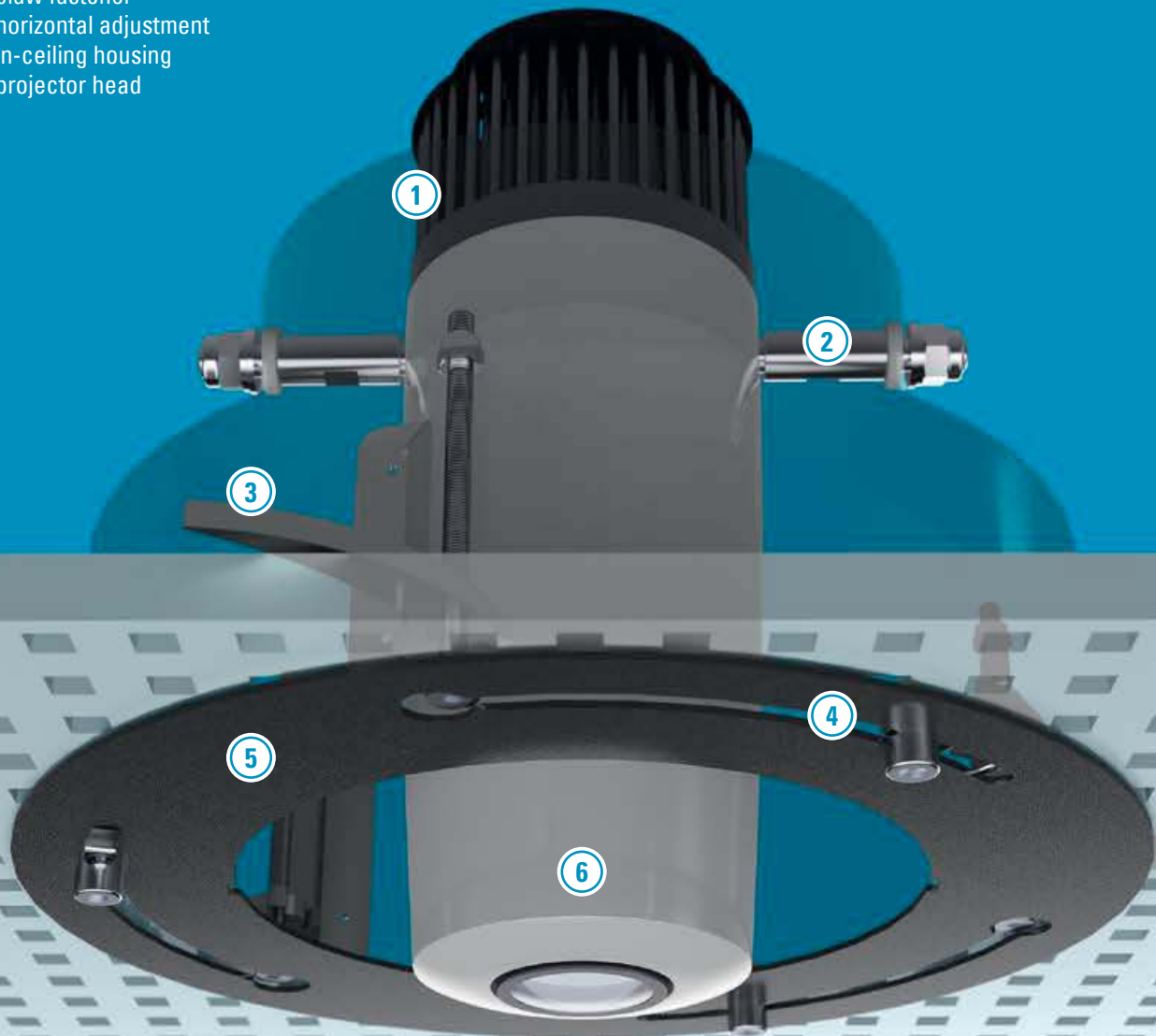



PHOS 25 downlight

output power: 22 W | 1,800 lumens
 recommended range: 2 – 6 m | 6.6 – 20 ft
 LED lifetime (L70): 35,000 hours
 cooling: passive – 0 dBA
 weight: 3.65 kg | 8.0 lbs
 dimensions (w x h x d): 243 x 236 x 243 mm
 8.07 x 10.32 x 8.07 inches

item number: 20025310 – white, 20025320 – black
 20025330 – silver
904.40 € | 760.00 €

PHOS 65 downlight

output power: 60 W | 3,800 lumens
 recommended range: 4 – 10 m | 13 – 33 ft
 LED lifetime (L70): 35,000 hours
 cooling: active cooling, fan – 20 dBA
 weight: 3.9 kg | 8.6 lbs
 dimensions (w x h x d): 243 x 236 x 243 mm
 8.07 x 10.32 x 8.07 inches

item number: 20065310 – white, 20065320 – black
 20065330 – silver
1475.60 € | 1240.00 €

PHOS 45 downlight

40 W | 2,700 lumens
 3 – 8 m | 9.8 – 26 ft
 35,000 hours
 active cooling, fan – 20 dBA
 3.8 kg | 8.4 lbs
 243 x 236 x 243 mm
 8.07 x 10.32 x 8.07 inches

20045310 – white, 20045320 – black
 20045330 – silver
1184.10 € | 995.00 €

PHOS 85 downlight

80 W | 5,750 lumens
 5 – 15 m | 16 – 50 ft
 35,000 hours
 active cooling, fan – 20 dBA
 3.9 kg | 8.6 lbs
 243 x 236 x 243 mm
 8.07 x 10.32 x 8.07 inches

20085310 – white, 20085320 – black
 20085330 – silver
1642.20 € | 1380.00 €

net price incl. 19% German VAT | excl. 19% German VAT



PHOS downlight deflection mirror

This special deflection mirror is used to deflect the projected image onto a wall. The mirror holder is magnetically attached to PHOS downlight and can be freely rotated to adjust the projection.

compatible lenses:	85 mm Standard Lens, Tele Booster
weight:	113 g 0.25 lbs
item number:	01024510 – white, 01024520 – black, 01024530 – silver
	130.90 € 110.00 €

net price incl. 19% German VAT
excl. 19% German VAT

We reserve the right to make technical and optical modifications. Our general terms and conditions apply.
All prices are the manufacturer's recommended retail prices (RRP) and can be subject to change without prior notification.



11.OG
^

1.UG
v

2.UG
v

2.UG
v

PHOS 25 – 85 outdoor

Specialist for Outdoor Use

This dust and weatherproof versions of PHOS LED projectors can be operated outdoors and in damp interiors. The lens is equipped with a special gasket, which prevents the penetration of moisture. All encapsulated electronic components are waterproof. The on / off switch was omitted. The projector is connected via a watertight

connection tube. Performance and specifications correspond to the standard version of PHOS 25 – 85.

With PHOS 85 outdoor a projection distance of more than 20 m (65 ft) is achievable at night. Possible applications include outdoor projections on facades or portals, advertise-

ments on pavements or surfaces in pedestrian zones. The projection motif (gobo) can be changed without tools. Due to Derksen's quick installation system, the projected image can be rotated and focused easily in a single operation. Several projection lenses with different focal lengths are available.



*PHOS outdoor with wide angle lens,
Installation by Detlef Hartung & Georg Trenz*





output power:
recommended range:
LED lifetime (L70):
cooling:
weight:
dimensions (w x h x d):

item number:

PHOS 25 outdoor

22 W | 1,800 lumens
2 – 6 m | 6.6 – 20 ft
35,000 hours
passive – 0 dBA
3.65 kg | 8.0 lbs
283 x 266 x 193 mm
11.14 x 10.47 x 7.60 inches

20025410 – white
20025420 – black
20025430 – silver
999.60 € | 840.00 €

PHOS 45 outdoor

40 W | 2,700 lumens
3 – 8 m | 9.8 – 26 ft
35,000 hours
active cooling, fan – 25 dBA
3.8 kg | 8.4 lbs
283 x 266 x 193 mm
11.14 x 10.47 x 7.60 inches

20045410 – white
20045420 – black
20045430 – silver
1606.50 € | 1350.00 €

output power:
recommended range:
LED lifetime (L70):
cooling:
weight:
dimensions (w x h x d):

item number:

PHOS 65 outdoor

60 W | 3,800 lumens
4 – 10 m | 13 – 33 ft
35,000 hours
active cooling, fan – 25 dBA
3.9 kg | 8.6 lbs
283 x 266 x 193 mm
11.14 x 10.47 x 7.60 inches

20065410 – white
20065420 – black
20065430 – silver
1761.20 € | 1480.00 €

PHOS 85 outdoor

80 W | 5,750 lumens
5 – 15 m | 16 – 50 ft
35,000 hours
active cooling, fan – 25 dBA
3.9 kg | 8.6 lbs
283 x 266 x 193 mm
11.14 x 10.47 x 7.60 inches

20085410 – white
20085420 – black
20085430 – silver
2153.90 € | 1810.00 €

net price incl. 19% German VAT | excl. 19% German VAT

We reserve the right to make technical and optical modifications. Our general terms and conditions apply.
All prices are the manufacturer's recommended retail prices (RRP) and can be subject to change without prior notification.

Seasonal projection with PHOS outdoor on a private house.



Frohe
Weihnachten



СВЯТА

Heilige

La Porte Sainte

Heilige Pfort

СВЯТАЄ ВОРՈՒՏԱ

Cologne Cathedral, announcing the "Year of The Holy Door" using PHOS outdoor projectors.



Holy Door
Poort

Sveta Vrata
Porta Sancta

圣门

i agia porta

سینٹ



PHOS 25 – 85 pole mount

Projectors for Street Lighting

In most cases masts made of steel or aluminum are used as support systems in street lighting. Derksen has developed a new mounting system, which is integrated in the new outdoor projectors of the "PHOS pole mount" series. This allows PHOS LED projectors to be easily installed in public space – without complex cabling and the installation of additional support systems.

An external LED driver is included, which is connected via a watertight connection tube to the projector. Alternatively PHOS pole mount comes with a driver that is already integrated in the fixture.

With PHOS 85 pole mount, the most powerful version, a projection distance of more than 20 m (65 ft.) is achievable at night. PHOS

pole mount is especially suitable for outdoor projections on facades or portals, messages on pavements or areas in pedestrian zones. The projection motif (gobo) can be changed without tools. Due to Derksen's quick installation system, the projected image can be rotated and focused easily in a single operation. Several projection lenses with different focal lengths are available.



"The Couch", artwork by Markus Brenner, Photo by Thomas Meier-Löpfe. Kreuzlingen (CH)



output power:
recommended range:
LED lifetime (L70):
cooling:
weight:
dimensions (w x h x d):

item number:

output power:
recommended range:
LED lifetime (L70):
cooling:
weight:
dimensions (w x h x d):

item number:

PHOS 25 pole mount

22 W | 1,800 lumens
2 – 6 m | 6.6 – 20 ft
35,000 hours
passive – 0 dBA
3.65 kg | 8.0 lbs
285 x 162 x 100 mm
11.22 x 6.38 x 3.94 inches

20025510 – white
20025520 – black
20025530 – silver
999.60 € | 840.00 €

PHOS 65 pole mount

60 W | 3,800 lumens
4 – 10 m | 13 – 33 ft
35,000 hours
active cooling, fan – 25 dBA
3.9 kg | 8.6 lbs
285 x 162 x 100 mm
11.22 x 6.38 x 3.94 inches

20065510 – white
20065520 – black
20065530 – silver
1761.20 € | 1480.00 €

PHOS 45 pole mount

40 W | 2,700 lumens
3 – 8 m | 9.8 – 26 ft
35,000 hours
active cooling, fan – 25 dBA
3.8 kg | 8.4 lbs
285 x 162 x 100 mm
11.22 x 6.38 x 3.94 inches

20045510 – white
20045520 – black
20045530 – silver
1606.50 € | 1350.00 €

PHOS 85 pole mount

80 W | 5,750 lumens
5 – 15 m | 16 – 50 ft
35,000 hours
active cooling, fan – 25 dBA
3.9 kg | 8.6 lbs
285 x 162 x 100 mm
11.22 x 6.38 x 3.94 inches

20085510 – white
20085520 – black
20085530 – silver
2153.90 € | 1810.00 €

net price incl. 19% German VAT | excl. 19% German VAT



output power:
recommended range:
LED lifetime (L70):
cooling:
weight:
dimensions (w x h x d):

item number:

PHOS 25s pole mount

22 W | 1,800 lumens
2 – 6 m | 6.6 – 20 ft
35,000 hours
passive – 0 dBA
3.65 kg | 8.0 lbs
285 x 358 x 225 mm
11.22 x 14.09 x 8.86 inches

20025610 – white
20025620 – black
20025630 – silver
1118.60 € | 940.00 €

PHOS 45s pole mount

40 W | 2,700 lumens
3 – 8 m | 9.8 – 26 ft
35,000 hours
active cooling, fan – 25 dBA
3.8 kg | 8.4 lbs
285 x 358 x 225 mm
11.22 x 14.09 x 8.86 inches

20045610 – white
20045620 – black
20045630 – silver
1725.50 € | 1450.00 €

output power:
recommended range:
LED lifetime (L70):
cooling:
weight:
dimensions (w x h x d):

item number:

PHOS 65s pole mount

60 W | 3,800 lumens
4 – 10 m | 13 – 33 ft
35,000 hours
active cooling, fan – 25 dBA
3.9 kg | 8.6 lbs
285 x 358 x 225 mm
11.22 x 14.09 x 8.86 inches

20065610 – white
20065620 – black
20065630 – silver
1880.20 € | 1580.00 €

PHOS 85s pole mount

80 W | 5,750 lumens
5 – 15 m | 16 – 50 ft
35,000 hours
active cooling, fan – 25 dBA
3.9 kg | 8.6 lbs
285 x 358 x 225 mm
11.22 x 14.09 x 8.86 inches

20085610 – white
20085620 – black
20085630 – silver
2153.90 € | 1810.00 €

net price incl. 19% German VAT | excl. 19% German VAT



PHOS 45 – 85 move

Compact System for Inspiring Lighting Effects

PHOS 45 – 85 move is characterized by its versatility. Thanks to its easily changeable effect options, flying or circling images can be projected onto any appropriate surface. All effect options are motorized and move projected images in different speed levels and in both directions. By a 3-button controller that is integrated in the base of the projector, all parameters can easily be set.

With PHOS 85 move, the most powerful version, a projection distance of more than 20 m (65 ft.) is achievable in darkness. The projection motif (gobo) can be changed without tools. Due to Derksen's quick installation system, the projected image can be rotated and focused easily in a single operation.

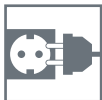

output power:
recommended range:
LED lifetime (L70):
cooling:
weight:
dimensions (w x h x d):

item number:

PHOS 45 move

40 W | 2,700 lumens
3 – 8 m | 9.8 – 26 ft
35,000 hours
active cooling, fan – 20 dBA
3.6 kg | 7.9 lbs
270 x 266 x 208 mm
10.63 x 10.47 x 8.19 inches

20045910 – white
20045920 – black
20045930 – silver
1422.10 € | 1195.00 €

PHOS 85 move

80 W | 5,750 lumens
5 – 15 m | 16 – 50 ft
35,000 hours
active cooling, fan – 20 dBA
3.8 kg | 8.4 lbs
270 x 266 x 208 mm
10.63 x 10.47 x 8.19 inches

20085910 – white
20085920 – black
20085930 – silver
1880.20 € | 1580.00 €

net price incl. 19% German VAT | excl. 19% German VAT

Effect Options

Modules with Motor Drives for Moving Images

Currently four different effect options are available for PHOS move – more coming soon. The options are installed on the projector head and can freely be rotated to aim the projected image at any appropriate

surface, e. g. floor, wall or ceiling. The effect modules are connected to the 12 V socket of PHOS move. Speed and direction of the movement can be set via the control buttons on the base of the projector.

Circular Motion Mirror

The projected image moves on a circular path. Speed, direction and diameter can be adjusted. The projection can be aimed at any surface, e. g. floor, wall or ceiling, by rotating the effect option on top of the projector.

angle of rotation:	360°
connector:	3.5 mm phone jack, 12 V
weight:	118 g 0.26 lbs
item number:	01004310 – white 01004320 – black 01004330 – silver
	249.90 € 210.00 €

net price incl. 19% German VAT | excl. 19% German VAT



Running Light

The projected image moves on a straight line in a single direction. Direction and speed are adjustable. The projection can be aimed at any surface, e. g. floor, wall or ceiling, by rotating the effect option on top of the projector.

angle of rotation:	360°
connector	3.5 mm phone jack, 12 V
weight:	198 g 0.44 lbs
item number:	01004610 – white 01004620 – black 01004630 – silver
	249.90 € 210.00 €



2-Facet Prism

The 2-Facet Prism displays two additional images that separate horizontally and then merge again into one. Direction and speed are adjustable. The projection can be aimed at any surface, e. g. floor, wall or ceiling, by rotating the effect option on top of the projector.

angle of rotation:	360°
connector	3.5 mm phone jack, 12 V
weight:	113 g 0.25 lbs
item number:	01004410 – white 01004420 – black 01004430 – silver
	249.90 € 210.00 €



4-Facet Prism

The 4-Facet Prism displays four additional images that separate horizontally and then merge again into one. Direction and speed are adjustable. The projection can be aimed at any surface, e. g. floor, wall or ceiling, by rotating the effect option on top of the projector.

angle of rotation:	360°
connector	3.5 mm phone jack, 12 V
weight:	153 g 0.34 lbs
item number:	01004510 – white 01004520 – black 01004530 – silver
	249.90 € 210.00 €



net price incl. 19% German VAT | excl. 19% German VAT

PHOS 85 rotator

Rotating Images Attract More Attention

PHOS 85 outdoor rotator rotates the projection motif permanently around its own axis. Rotational speed and direction are adjustable. A moving image attracts more attention than a static projection. The projector offers an uncompromising brightness with its air-cooled 80 Watt high-performance LED, which guarantees brilliant and high-contrast projections. The device is suitable for humid interiors or year-round outdoor use. Maximum projection distance is 8 meters

(26 feet) for room lighting and 20 meters (65 feet) for twilight or at night. Recommended applications include: Projections on facades or sidewalks in busy inner cities. The motif (gobo) can be changed without tools. Several projection lenses with various focal lengths are available.

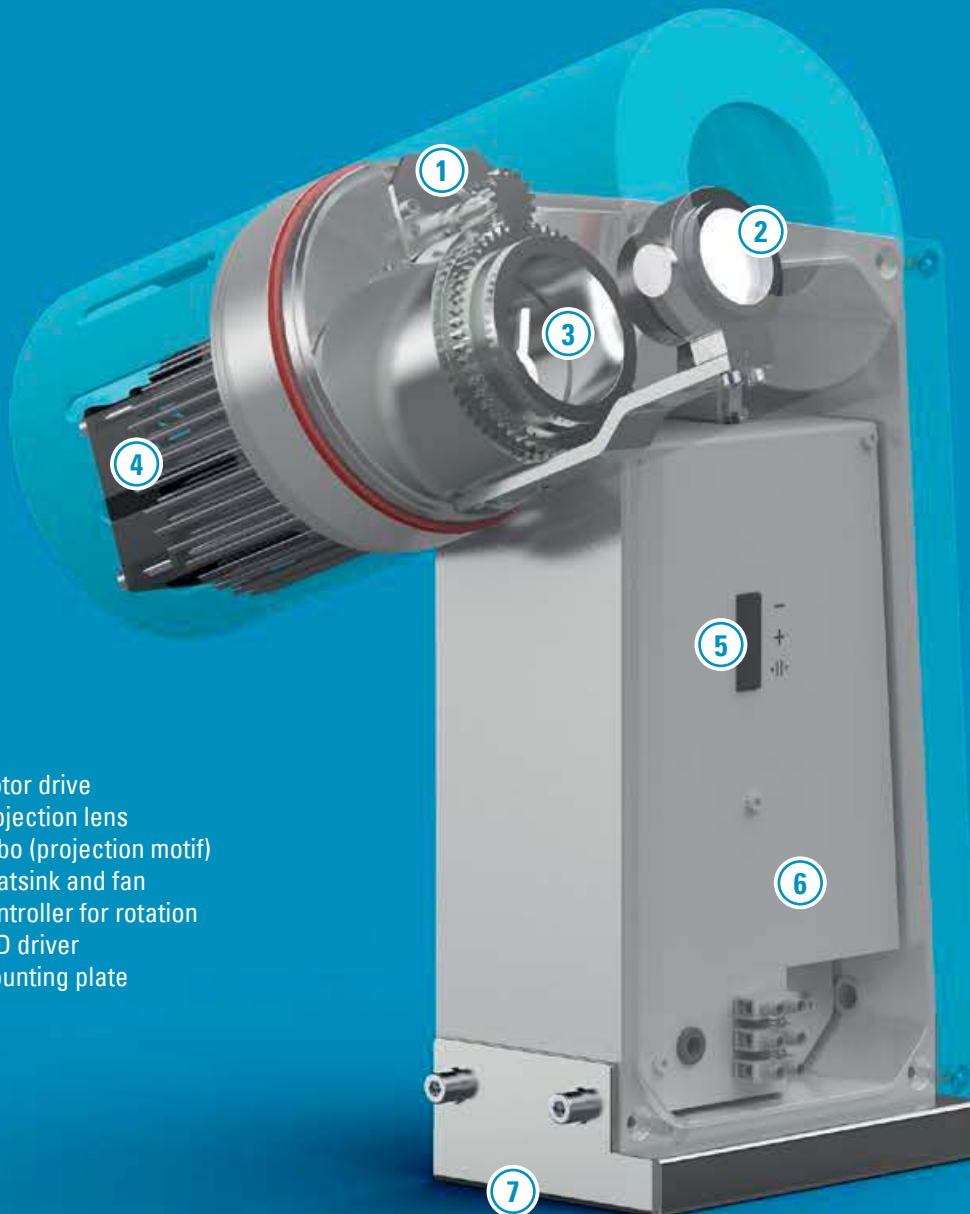

- 1 – motor drive
- 2 – projection lens
- 3 – gobo (projection motif)
- 4 – heatsink and fan
- 5 – controller for rotation
- 6 – LED driver
- 7 – mounting plate



PHOS 85 rotator outdoor

output power:	80 W 5,750 lumens
max. projection range:	5 – 15 m 16 – 50 ft
LED lifetime (L70):	35,000 hours
cooling:	active cooling, fan – 28 dBA
weight:	7.4 kg 16.3 lbs
dimensions (w x h x d):	293 x 331 x 278 mm 11.54 x 13.03 x 10.94 inches
item number:	20085830 – silver

2972.60 € | 2498.00 €

net price incl. 19% German VAT | excl. 19% German VAT

Virtual Safety Signs

Projected Images to Prevent Risks and Optimize Work Flows

Floor marking and safety signage is widely used in industrial facilities and warehouses to optimize workflows and prevent risks. Highly visible, colored marks indicate aisles, pathways and danger zones, the flow of goods and traffic is effectively directed. The conventional way is to apply heavy-duty adhesive tapes, labels or paint to the floor. In many situations these methods are impractical because the markings must frequently be replaced due to wear and tear. Replacing old labels or paint is time-consuming and expensive.

Projected floor markings and safety signs do not wear off, even in heavy traffic areas. No more need of constantly replacing old labels! Our projection systems are equipped with LED light sources that last 35.000 operating hours (L70). The projection motifs (gobos) are 100% durable and can be customized according to your own design. The projection motif can easily be changed without any tools. PHOS safety projectors are dust-proof and because of its compact design they can safely be mounted out of

the way of forklifts and other heavy vehicles. You can adjust the resulting projection size by selecting a lens option.

Projected markings and safety signs are clearly visible even in poor lighting conditions and on uneven surfaces. As an active warning, the projected image can automatically be switched on and off, e. g. when a vehicle is approaching. With PHOS 85 rotator the image can be rotated with adjustable speed to attract even more attention.



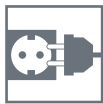

output power: 40 W | 2,700 lumens
 max. projection range: 3 – 8 m | 9.8 – 26 ft
 LED lifetime (L70): 35,000 hours
 cooling: active cooling, fan – 28 dBA
 weight: 7.4 kg | 16.3 lbs
 dimensions (w x h x d): 293 x 331 x 278 mm
 11.54 x 13.03 x 10.94 inches

item number: 20045830 – silver

2189.60 € | 1840.00 €

net price incl. 19% German VAT | excl. 19% German VAT

PHOS 85 rotator indoor

output power: 80 W | 5,750 lumens
 max. projection range: 5 – 15 m | 16 – 50 ft
 LED lifetime (L70): 35,000 hours
 cooling: active cooling, fan – 28 dBA
 weight: 7.4 kg | 16.3 lbs
 dimensions (w x h x d): 293 x 331 x 278 mm
 11.54 x 13.03 x 10.94 inches

item number: 20850030 – silver

2615.60 € | 2198.00 €

PHOS Projection Lenses

Interchangeable projection lenses are used to adjust the size of the projected image. Wide angle lenses are useful when a large image is required over a short distance. On the other side, telephoto lenses make it possible to project images over long distances. Several focal length are available in order to meet your individual demands. With every PHOS projector, an 85 mm standard lens is included which can be exchanged without any tools.

View the projection size diagram on the right to choose the optimal focal length. Please note that these are approximate values. The result may differ slightly in reality. The calculation applies under the following conditions:

1. The projection motif is circular and fills the entire image area of the gobo. Other shapes and objects, such as rectangles or texts, are fitted into this.

2. The image is projected at right angles to the projection screen.
3. The projection screen is plane.
4. The distance is measured between the lens and the projection screen.

Projection lenses are available for any indoor and outdoor version of PHOS 25 – 85 and PHOS rotator. Tele Booster is recommended for PHOS 25 – 45 only.



Lens Kit Wide Angle 45 mm

compatible projectors:	PHOS 25 – 85 (all indoor versions), PHOS rotator
focal length:	45 mm
gobo size image size:	50 mm 40 mm
item number:	02010920
net price incl. 19% VAT:	274.00 €
net price excl. 19% VAT:	230.00 €



Lens Kit Wide Angle 45 mm outdoor

compatible projectors:	PHOS 25 – 85 (all outdoor versions)
focal length:	45 mm
gobo size image size:	50 mm 40 mm
item number:	02010810 (white), 02010820 (black), 02010830 (silver)
net price incl. 19% VAT:	381.00 €
net price excl. 19% VAT:	320.00 €



Lens Kit Wide Angle 63 mm

compatible projectors:	PHOS 25 – 85 (all indoor & outdoor versions), PHOS rotator
focal length:	63 mm
gobo size image size:	50 mm 40 mm
item number:	02010320
net price incl. 19% VAT:	148.00 €
net price excl. 19% VAT:	124.00 €



Standard Lens 85 mm

compatible projectors:	PHOS 25 – 85 (all indoor & outdoor versions), PHOS rotator
focal length:	85 mm
gobo size image size:	50 mm 40 mm
item number:	09955120
net price incl. 19% VAT:	69.10 €
net price excl. 19% VAT:	58.00 €

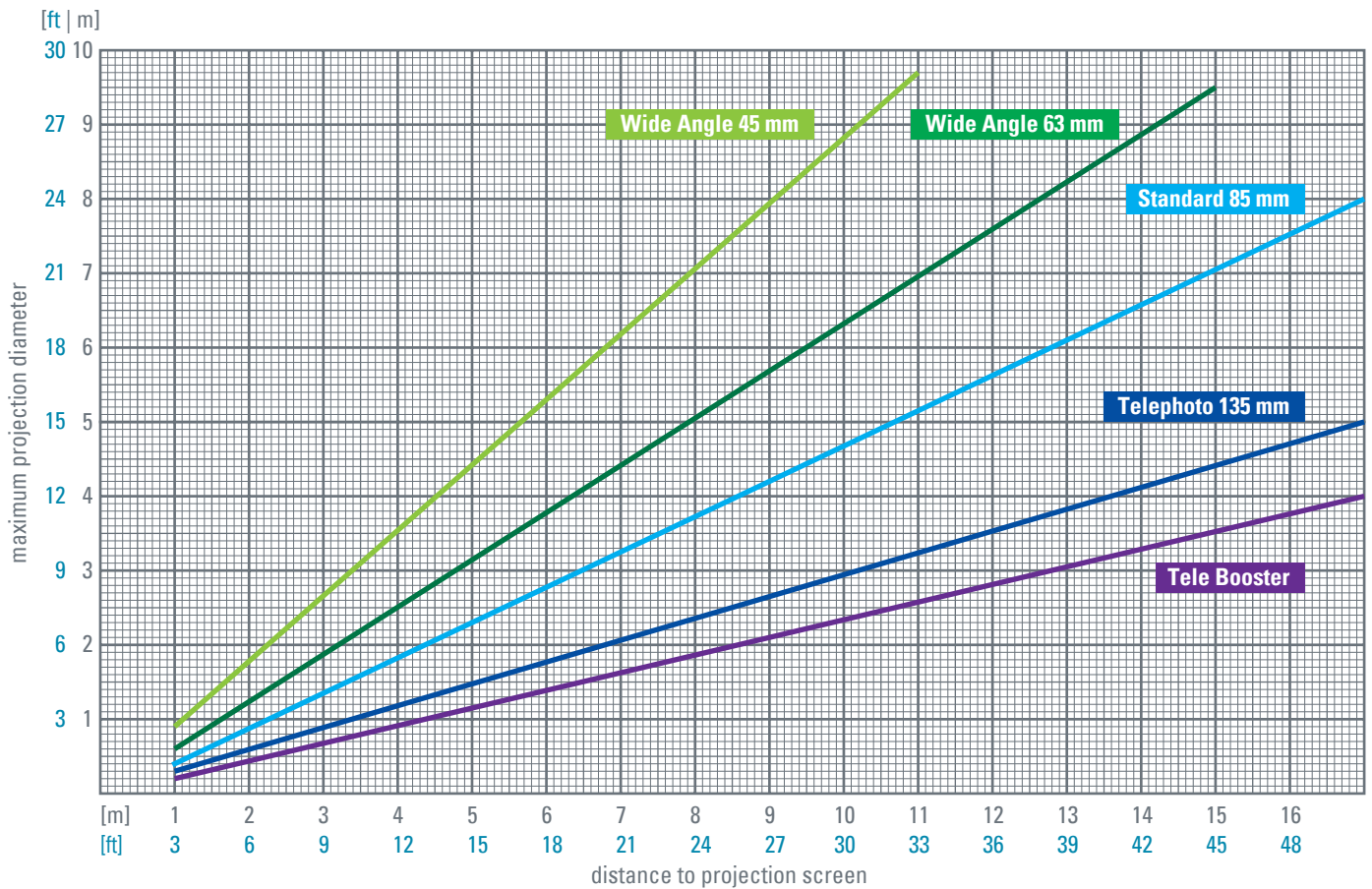

Lens Kit Telephoto 135 mm

compatible projectors: PHOS 25 – 85 (all indoor versions), PHOS rotator
 focal length: 135 mm
 gobo size | image size: 50 mm | 40 mm
 item number: 02011110 (white), 02011120 (black), 02011130 (silver)
net price incl. 19% VAT: 381.00 €
 net price excl. 19% VAT: 320.00 €



Lens Kit Telephoto 135 mm outdoor

compatible projectors: PHOS 25 – 85 (all outdoor versions)
 focal length: 135 mm
 gobo size | image size: 50 mm | 40 mm
 item number: 02011210 (white), 02011220 (black), 02011230 (silver)
net price incl. 19% VAT: 417.00 €
 net price excl. 19% VAT: 350.00 €



Tele Booster

compatible projectors: PHOS 25 – 45 (indoor & outdoor versions)
 focal length: 85 mm
 gobo size | image size: 37,5 mm | 20 mm
 item number: 02011030
net price incl. 19% VAT: 274.00 €
 net price excl. 19% VAT: 230.00 €

We reserve the right to make technical and optical modifications. Our general terms and conditions apply.
 All prices are the manufacturer's recommended retail prices (RRP) and can be subject to change without prior notification.

Colour Correction Filters



item:
converts 6000 K into:
size:
item number:

Colour Correction Filter 3000 Kelvin
3000 K
Ø 50 mm
09960100
57.20 €
48.00 €

Colour Correction Filter 4000 Kelvin
4000 K
Ø 50 mm
09960200
57.20 €
48.00 €

net price incl. 19% German VAT | excl. 19% German VAT



without colour filter – ca. 6,000 Kelvin



Colour Correction Filter 4,000 Kelvin



Colour Correction Filter 3,000 Kelvin

We reserve the right to make technical and optical modifications. Our general terms and conditions apply.
All prices are the manufacturer's recommended retail prices (RRP) and can be subject to change without prior notification.



Custom Product Development

A Message in the Cleaning Foam

Who hasn't spent time in a car wash, waiting impatiently behind the wheel, with the question in mind, what's going on outside? Will the premium wash, for which I have paid an extra charge, actually be applied? Due to the limited visibility in a car wash, it is a technical challenge to communicate the sequence of the washing program.

Mr. Wash opened one of the first automatic washers in Dusseldorf in 1964. Meanwhile, the company has grown continually. All 30

branches are located near busy main roads in major German cities. Annually approx. 6 million cars are washed. High environmental standards in the recovery and treatment of cleaning water are part of the company philosophy, as well as a comprehensive, versatile range of services, such as internal cleaning or waxing by hand.

The LED projector with 40 W power and a brightness of 2,700 lumens is mounted in front of the cleaning brushes on a cross-

beam. The device is connected to the computer hardware of the car wash and is automatically switched on when the vehicle is sprayed with active cleaning foam. The projection only appears on vehicles that have chosen such a premium feature. The projected text "aktiv schau" slides over the windshield as the vehicle is moved toward the brushes. The text is readable from the interior through the foam layer.

custom product development for
Mr. Wash Auto Service AG, www.mrwash.de





This exceptional environment presented some challenges for Derksen's development team:

- Different vehicle sizes and types had to be taken into account.
- The aggressive washing solution affects the housing of the projector, which was therefore constructed of V2A stainless steel with an acid-resistant front glass.
- The impact of daylight in the entrance area could be compensated by the use of a high-luminosity LED.

GLASS GOBOS

What is a Gobo?

The word "gobo" is used in the world of light and lighting to mean a shaped template which is held in front of a light source to form a particular image in the light beam. The origins of the word are not proven but some sources quote it as possibly being an acronym for "graphical optical black out" (Wikipedia.org).

Glass Gobos from Derksen

Gobos with simple shapes are made out of sheet metal whilst the more complicated and coloured graphics used for the majority of images are reproduced on glass gobos. Typically any free area in a metal gobo has to be connected to the gobo via a web, the inside of the letter O for instance, but the creativity allowed by glass gobos knows no bounds. Logos, graphics or texts of extremely high quality can be projected to appeal to the public. Even photographic pictures can be transferred onto glass gobos using a four coloured raster grid (CMYK). They can be in continuous use professionally and hold their colour whereas traditional slides and films begin to fade after a short time.

Custom Made Motifs **52**

Dichroic Standard Colours **54**

Artwork Formats and Ordering **57**

Custom Made Motifs

Glass Gobos Carrying Your Individual Artwork

Glass gobos in any size

Gobos with simple shapes are made out of steel whilst the more complicated and coloured graphics used for the majority of images are reproduced on glass gobos. Typically any free area in a metal gobo has to be connected to the gobo, the inside of the letter O for instance. The creativity allowed by glass gobos is almost limitless. Logos, graphics or texts of extremely high quality can be projected onto any suitable surface. Even photographic images can be transferred onto glass gobos using a four

colour screen (CMYK). In continuous, professional use they hold their colour whereas traditional slides and films begin to fade after a short time. Derksen produces glass gobos in various sizes ranging from 22.5 to 105 mm diameter so they are compatible with every projection system on the market.

24-hours turnaround

If we get an artwork file which meets our requirements (vector file or pixel file) before 12 am, the gobo can be shipped or picked up the same day.

Transparent pricing

Derksen offers its customers a transparent pricing without additional charges. Glass gobos are classified in 7 categories depending on the number of layers and the imaging process. Thereby customers are able to calculate costs when designing custom artworks.

Cost-saving reorders

Your artwork files will be archived for at least 5 years. When you reorder, you will only pay the lower duplicate price.



net price incl. 19% German VAT | excl. 19% German VAT

Simple laser-processed Gobos

Black & White

Glass gobo without colour.

first gobo: 100.00 € | 84.00 €
duplicate: 63.10 € | 53.00 €



Black & Colour

Glass gobo with a single, unprocessed colour filter

first gobo: 116.70 € | 98.00 €
duplicate: 81.00 € | 68.00 €



Gobos subjected to multiple pass laser processing

Colour 1

Glass gobo with 1 laser-processed colour filter.

first gobo: 188.10 € | 158.00 €
duplicate: 138.10 € | 116.00 €



Colour 2

Glass gobo with 2 laser-processed colour filters

first gobo: 302.30 € | 254.00 €
duplicate: 216.60 € | 182.00 €



Colour 3

Glass gobo with 3 laser-processed colour filters

first gobo: 418.90 € | 352.00 €
duplicate: 330.90 € | 278.00 €



Screened gobos to create colour progressions

Greyscale

Glass gobo with greyscale

first gobo: 133.30 € | 112.00 €
duplicate: 100.00 € | 84.00 €



Multicolour

CMYK glass gobo with 4c colour filters

first gobo: 507.00 € | 426.00 €
duplicate: 405.80 € | 341.00 €



We reserve the right to make technical and optical modifications. Our general terms and conditions apply.

All prices are the manufacturer's recommended retail prices (RRP) and can be subject to change without prior notification.

Dichroitic Standard Colours

Dichroic colour filters stand out because of their high saturation and brilliance. A palette of thirteen standard filters is available to give your artwork the required colours. If special colours are needed, for instance in your corporate design, we can meet your requirements either by mixing colours or by developing custom filters when a larger number of pieces is requested.

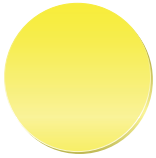

Yellow
ca. Pantone
Process Yellow C



Warm Yellow
ca. Pantone 137 C

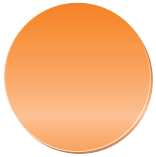

Orange
ca. Pantone 151 C



Warm Red
ca. Pantone 485 C



Pink
ca. Pantone 225 C



Warm Pink
ca. Pantone 237 C



Magenta
ca. Pantone
Process Magenta C

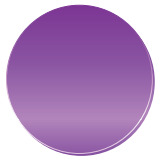

Violet
ca. Pantone 254 C



Medium Blue
ca. Pantone 300 C



Light Blue
ca. Pantone
Process Cyan C



Blue-Green
ca. Pantone 321 C



Cool Green
ca. Pantone 3288 C

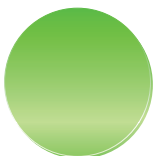

Warm Green
ca. Pantone 368 C

All colour details rely on a projection using a 6000 Kelvin light source onto a neutral white back-drop and please note that every colour reproduced on screen is individual. Slight colour variations on this page are technically caused and can't be avoided.





SHA, Hadrian 19,2

»in omnibus paene urbibus
et aliquid aedificavit...«

»Fast in allen Städten hat er [Kaiser Hadrian] Bauten errichten lassen...«

»Bijna in alle steden heeft hij [keizer Hadrianus] bouwwerken laten oprichten...«

»In almost all towns he [Emperor Hadrian] had buildings erected...«



Artwork File Formats

Vector Files

Vector data describes simple or complex graphics which use mathematical formulae to set out the origin, direction, size and colour etc. of an area or line. The essential advantage of vector data is that the graphics can be blown up to any size without any loss of quality.

Vector File Types:	Gobo Categories:
--------------------	------------------

Adobe Illustrator (.ai)
Portable Document Format (.pdf)
Corel Draw (.cdr)
Encapsulated Postscript (.eps)

Black & White
Black & Colour
Colour 1
Colour 2
Colour 3



Pixel Files

Pixel data are recommended for use in reproducing photographic material. All digital cameras and scanners use pixel data but the one drawback is that pixel data can't be blown up bigger than the original data without a loss of quality. Large data is often required to reproduce detailed and sharp photographic images.

Pixel File Types:	Gobo Categories:
-------------------	------------------

JPEG (.jpg, quality setting „maximum“)
TIFF (.tif, LZW data compression allowed)
Adobe Photoshop (.psd)

Greyscale
Multicolour



In order to avoid difficulties representing fonts in vector files, the whole text should be converted into paths. Please screen Photoshop layers with text before submitting. If you're not sure about choosing the right data we're happy to help. The above information is only intended as a guide.

Ordering

We check your digital artwork and make a quotation free of cost and without any obligation.

Gobo-Hotline: **+49 (0)2 09 9 80 70-51**
E-Mail: **gobo@derksen.de**

ACKNOWLEDGMENTS

Published by: Derksen Lichttechnik GmbH, Gelsenkirchen
Conception, design and photography are a collaborative effort of the designers and the marketing team of our company.

For the friendly support of our photo projects we would like to thank:

Archbishopric of Cologne
Cathedral Works Cologne
Detlef Hartung & Georg Trenz, light artist
Heinz Nixdorf MuseumsForum, Paderborn
IKEA Essen
Jades GmbH, Dusseldorf
Lindner Hotels AG
Markus Brenner, artist, Constance
me and all hotel Dusseldorf
Mr. Wash Autoservice AG, Essen
Pixum/Diginet GmbH & Co. KG, Köln
RheinEnergie Cologne
Römermuseum, Archäologischer Park Xanten
Sandtler GmbH, Bochum
Sayonara Visual Concepts, Dusseldorf

We reserve the right to make technical and optical modifications.
Possible color deviations are due to printing technology.
© Copyright by Derksen Lichttechnik GmbH, March 2018

Symbol Explanation - Legend



for dry indoor environments only



suitable for outdoor use or damp rooms



IP rating

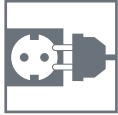

ready for plug-in, with power plug



device is equipped with a mains switch



image size and diameter of the gobo (measured in mm)



external power-supply unit included



with adaptor for 3-phase lighting tracks



recessed downlight for in-ceiling mount



noiseless



device is equipped with a noise-optimized fan

Photo Credits

Pages 2 – 3

Lighthouse List West after sunset,
Location: Sylt, North Sea
 ©Lightboxx - stock.adobe.com

Pages 8 – 9:

Location: IKEA Essen

Page 11:

Location: Heinz Nixdorf MuseumsForum
 Fürstenallee 7, 33102 Paderborn
Media and Event Technology:
 Dipl.-Ing. Reinhardt Hardtke

Pages 12, 30 – 31:

Location: Cologne Cathedral
Client: Archbishopric of Cologne
Technical Implementation:
 RheinEnergie Köln
 Photo by Markus Lück & Frank Brauer
 by courtesy of Dombauhütte Köln

Pages 12 – 14, 25:

Location: me and all hotel
 Immermannstrasse 23, 40210 Dusseldorf
Client: Lindner Hotels AG

Page 17:

Location: JADES Dusseldorf
 Heinrich-Heine-Allee 53, 40213 Dusseldorf
 www.jades24.com
Concept: Domagoj Mrcic,
 sayonara visual concepts

www.sayonara-visual-concepts.com
Photo: Uschi Fellner

Page 20:

Location: Sandtler GmbH, Showroom
 Heidestraße 85 b, 44866 Bochum
 www.sandtler24.de
 Photo by Markus Lück & Frank Derksen

Page 27:

“Von Grund auf & Lichtwuchs”, two permanent outdoor installations, private collection, cologne
Artistic Concept: Detlef Hartung & Georg Trenz, www.hartung-trenz.de
Photo: Detlef Hartung

Page 29:

Location: Ratingen, private house

Page 33:

Location: Bellevue Park
 8280 Kreuzlingen, Switzerland
Client: City of Kreuzlingen
Artist: Markus Brenner, Constance
 www.markusbrenner.com
Concrete Work: GODELMANN Manufaktur
Photo: Thomas Meier-Löpfle
 www.meier-loepfe.ch

Page 43:

Workers in a warehouse
 ©industrieblick - Fotolia

Page 47:

Location: Pixum/Dignet GmbH Co. KG
 Industriestraße 161, 50999 Cologne
 www.pixum.com

Pages 48 – 49:

Location: Mr. Wash Autoservice AG
 Hans-Böckler-Str. 23, 45127 Essen
 www.mrwash.de

Page 52:

Young Blue-and-yellow Macaw –
 Ara ararauna (8 months)
 © www.lifeonwhite.com – iStock

Page 55:

“Big Brother in Trouble”, artwork by
 kabay seventyeight – tshirt-factory.com
Location: Gelsenkirchen, A42, AS Schalke

Page 56:

Location: LVR-RömerMuseum Xanten
 Trajanstr. 4, 46509 Xanten
 www.apx.lvr.de
Lighting Design: Kress & Adams, Cologne

All photos, unless otherwise stated, by
 Markus Lück & Frank Brauer
 Derksen Lichttechnik GmbH



derksen®
lichttechnik

Derksen Lichttechnik GmbH
Johannes-Rau-Allee 4
45889 Gelsenkirchen
Germany

phone: +49 (0)209 / 9 80 70 0

email: info@derksen.de
web: www.derksen.de