

PHOS 25 downlight is equipped with the latest LED technology and is passively cooled without a fan. This budget-priced entry level model is suitable for dry indoor environments and can be unobtrusively installed in false ceilings. The projector is perfect for applications in small shops, doctors' offices and chemist's shops. The included electronic ballast is placed in the false ceiling. The projection motif (gobo) can be changed without tools.

### Construction

housing: ..... aluminium, steel, powder coated  
 weight (standard equipment): ..... 3.65 kg | 8.05 lbs  
 On / Off switch: ..... not available  
 IP-rating of the housing ..... IP 20

### Operating Conditions

application area ..... dry interiors, in-ceiling installation  
 ambient temperature: ..... -30°C - +35°C  
 cooling: ..... passive, noiseless, 0 dBA

### Light Source and Optics

light source: ..... High Power LED, 22 W  
 luminous flux of the projector: ..... 1,574 lumens  
 efficiency ..... 58 lumens / watt  
 colour temperature: ..... 6,300 – 6,700 K  
 colour rendering index: ..... Ra >70  
 estimated lifetime of the LED (L70): ..... 35,000 operating hours  
 projection lens: ..... Standard Lens, f=85 mm (included)  
 gobo size / image size: ..... Ø 50.0 mm / Ø 40.0 mm  
 photobiological safety (ICE62471-5:2015, EN62471-5:2015): ..... RG-2

### Electrical Specifications

input voltage: ..... 220 - 240V AC, 50/60 Hz  
 power consumption: ..... 27 W  
 power factor: ..... 0.9 cos φ  
 electrical protection class: ..... II  
 max. number of devices per circuit breaker B16A/C16A: ..... 30/51  
 device is dimmable: ..... no  
 electronic ballast: ..... external (included)

**Item No.:** 20025310 (white), 20025320 (black), 20025330 (silver)

**Additional Accessories:** individual glass gobo according to your digital artwork, Extra Wide Angle Lens, f=45 mm, Wide Angle Lens, f=63 mm, Telephoto Lens, f=135 mm, deflection mirror for wall projection

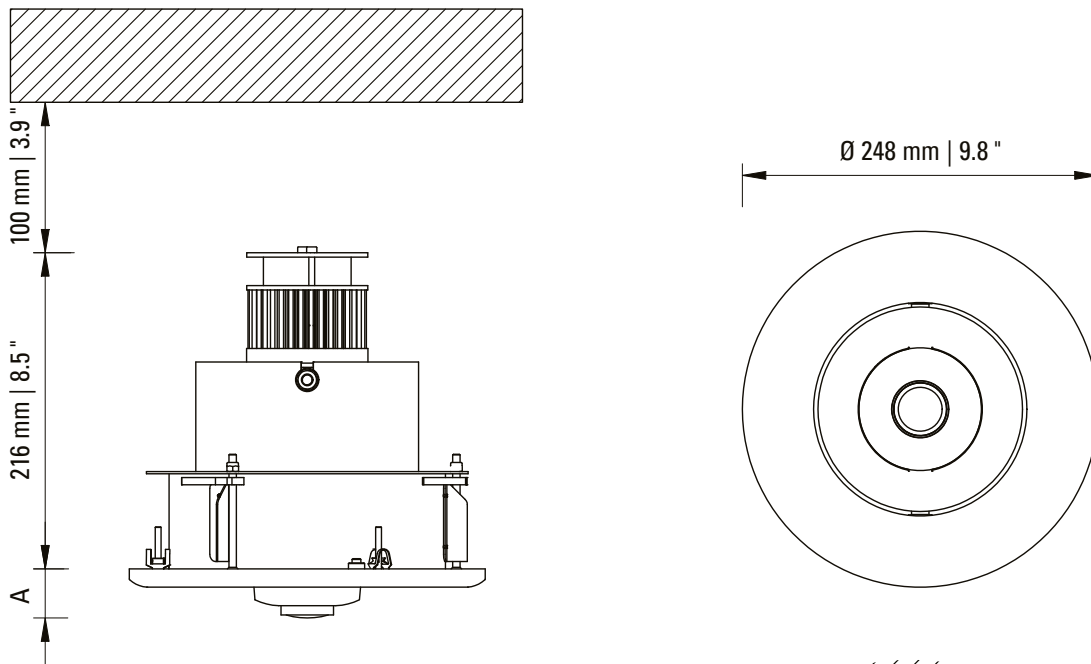

**Ceiling cut-out**

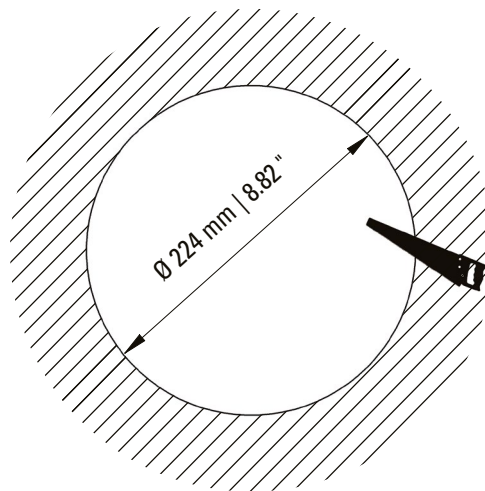
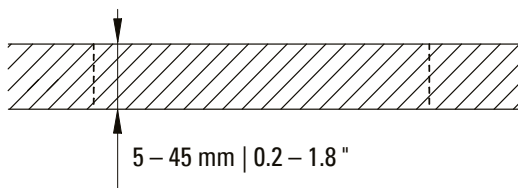

| Projection Lens           | Height A       |
|---------------------------|----------------|
| Extra Wide Angle, f=45 mm | 59 mm   2.3 "  |
| Wide Angle, f=63 mm       | 25 mm   1.0 "  |
| Standard, f=85 mm         | 31 mm   1.2 "  |
| Telephoto, f=135 mm       | 100 mm   3.9 " |



# PHOS downlight Deflection Mirror

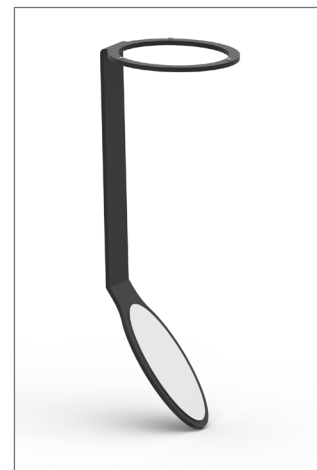
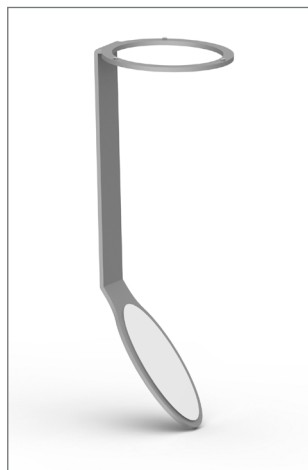

## PHOS downlight Deflection Mirror

This special deflection mirror is used to deflect the projected image onto a wall. The mirror holder is magnetically attached to PHOS downlight and can be freely rotated to adjust the projection.

### Construction

material:.....aluminium, powder coated, mirror glass  
weight: ..... 113 g | 0.25 lbs  
compatible projection lens:..... Standard Lens, f=85 mm

**Item No.:** 01024510 (white), 01024520 (black), 01024530 (silver)

# PHOS 25 downlight – Photometric Diagrams

## PHOS 25, Extra Wide Angle Lens, f = 45 mm, 48°

illuminance [lux]

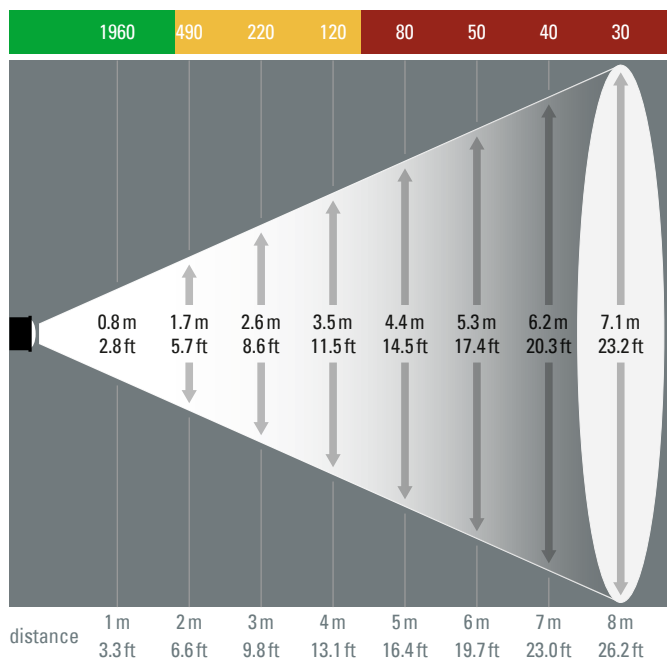

## PHOS 25, Wide Angle Lens, f = 63 mm, 35°

illuminance [lux]

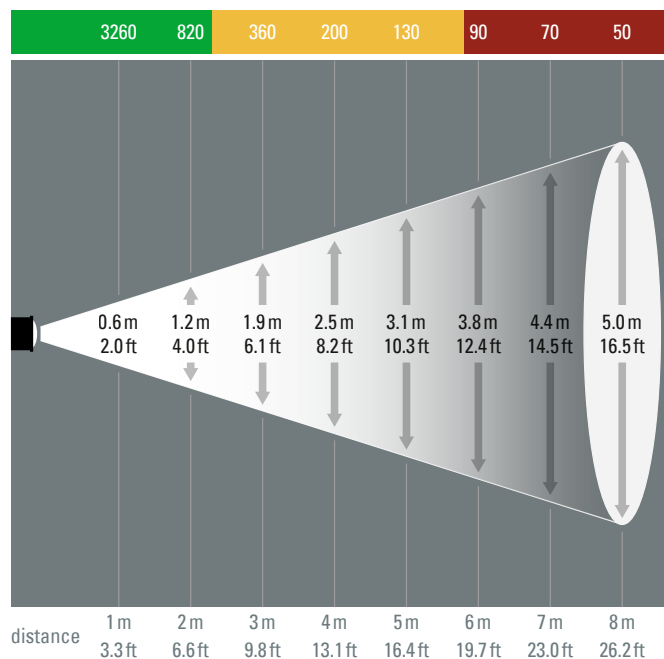

## PHOS 25, Standard Lens, f = 85 mm, 26°

illuminance [lux]

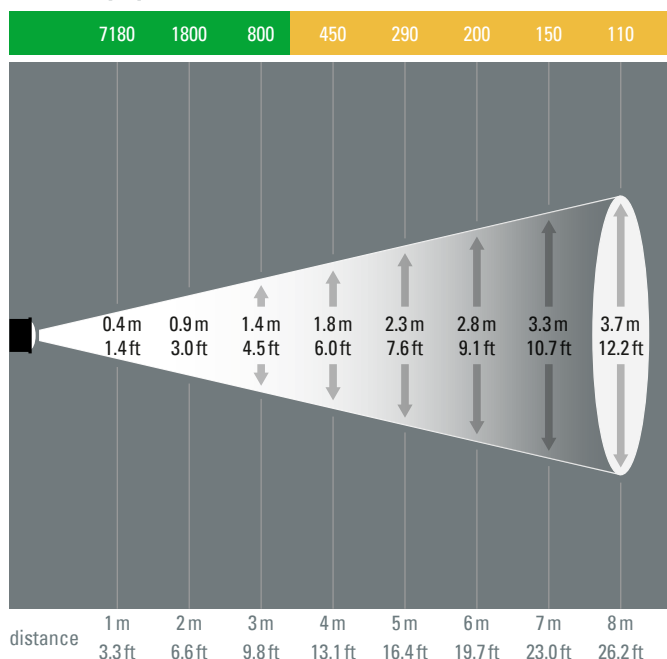

## PHOS 25, Telephoto Lens, f = 135 mm, 17°

illuminance [lux]

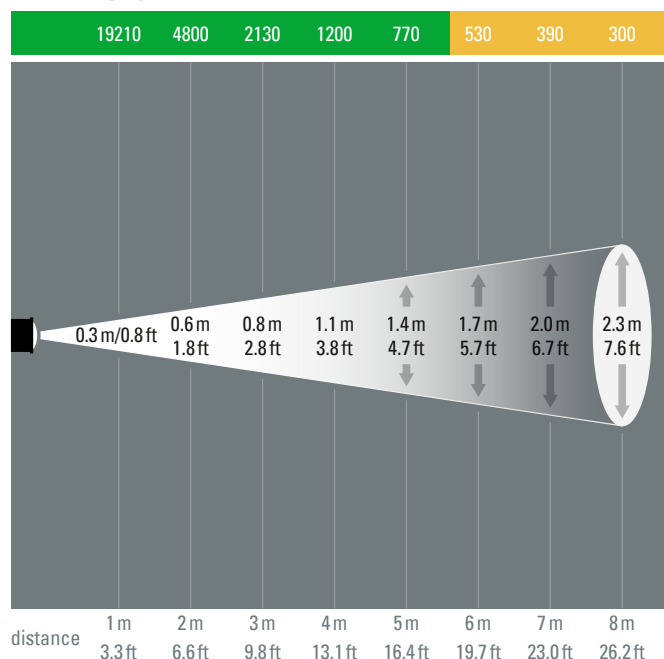

### Brightness Colour Coding:

- = with standard room lighting, suitable for coloured motifs
- = in low-light rooms, for motifs without colour
- = recommended only in darkened rooms

- The results shown are approximate values. The result may differ slightly in reality.
- The projection sizes indicate the maximum diameter that can be projected with a Ø 40 mm image.
- The projection motif is circular and fills the image area of the gobo. Other objects, e.g. rectangles or texts are fitted into the circular projection area.
- The projection is at right angles to the projection surface.

Detailed projection calculator at: [www.derksen.de](http://www.derksen.de)

derksen®  
lichttechnik

Derksen Lichttechnik GmbH  
Johannes-Rau-Allee 4  
45889 Gelsenkirchen  
Germany

Tel.: +49 209 98070-0  
info@derksen.de  
www.derksen.de