

The 40 Watt High-Power LED of PHOS 45 downlight is sufficiently cooled by a noise-optimized fan and provides extra power. The device is suitable for dry indoor environments and can be unobtrusively installed in false ceilings. PHOS 45 downlight is recommended for environments like salesrooms, service halls, trade fairs and museums. The included electronic ballast is placed in the false ceiling. The projection motif (gobo) can be changed without tools.

Construction

housing: aluminium, steel, powder coated
 weight (standard equipment): 3.8 kg | 8.38 lbs
 On / Off switch: not available
 IP-rating of the housing IP 20

Operating Conditions

application area dry interiors, in-ceiling installation
 ambient temperature: -30°C - +35°C
 cooling: active, with a fan, 27 dBA

Light Source and Optics

light source: High Power LED, 40 W
 luminous flux of the projector: 2,388 lumens
 efficiency 54 lumens / watt
 colour temperature: 6,300 – 6,700 K
 colour rendering index: Ra >70
 estimated lifetime of the LED (L70): 35,000 operating hours
 projection lens: Standard Lens, f=85 mm (included)
 gobo size / image size: Ø 50.0 mm / Ø 40.0 mm
 photobiological safety (ICE62471-5:2015, EN62471-5:2015): RG-2

Electrical Specifications

input voltage: 220 - 240V AC, 50/60 Hz
 power consumption: 44 W
 power factor: 0.95 cos φ
 electrical protection class: II
 max. number of devices per circuit breaker B16A/C16A: 30/51
 device is dimmable: no
 electronic ballast: external (included)

Item No.: 20045310 (white), 20045320 (black), 20045330 (silver)

Additional Accessories: individual glass gobo according to your digital artwork, Extra Wide Angle Lens, f=45 mm, Wide Angle Lens, f=63 mm, Telephoto Lens, f=135 mm, deflection mirror for wall projection

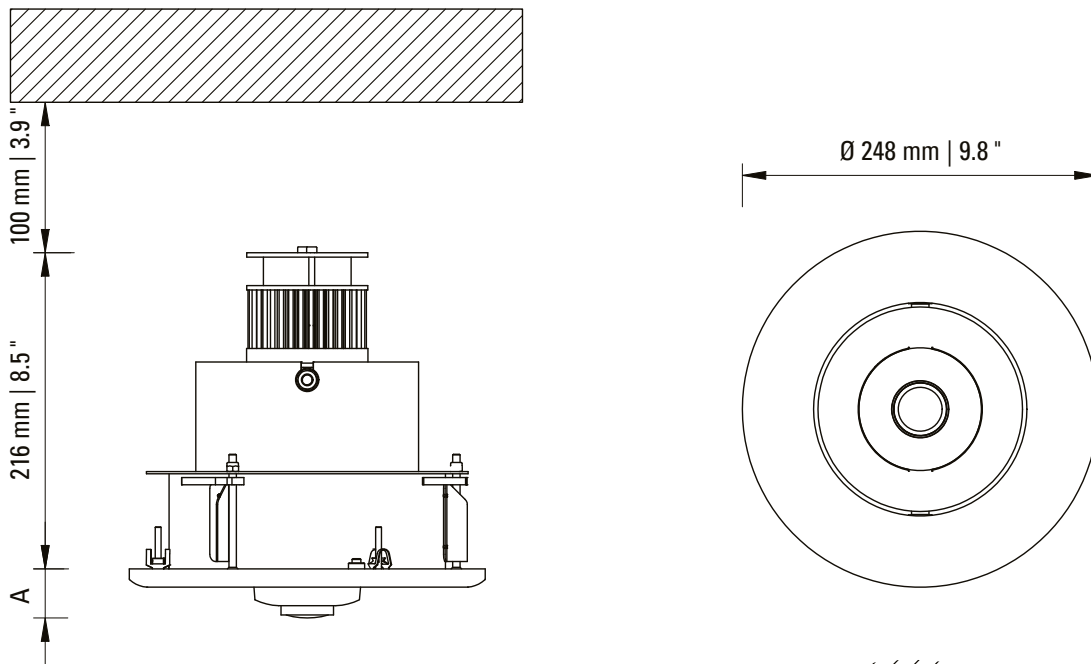

Ceiling cut-out

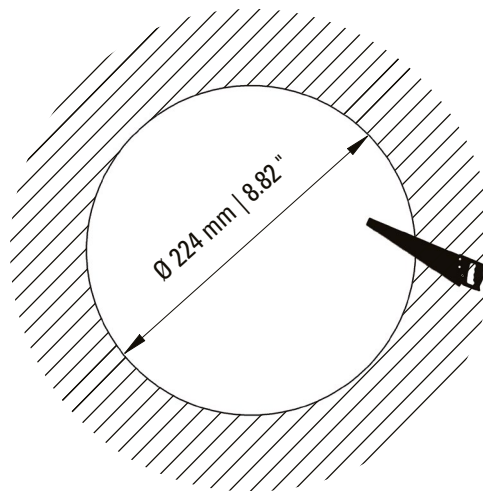
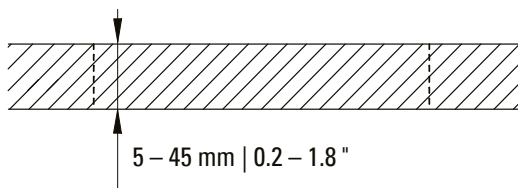

Projection Lens	Height A
Extra Wide Angle, f=45 mm	59 mm 2.3 "
Wide Angle, f=63 mm	25 mm 1.0 "
Standard, f=85 mm	31 mm 1.2 "
Telephoto, f=135 mm	100 mm 3.9 "



PHOS downlight Deflection Mirror

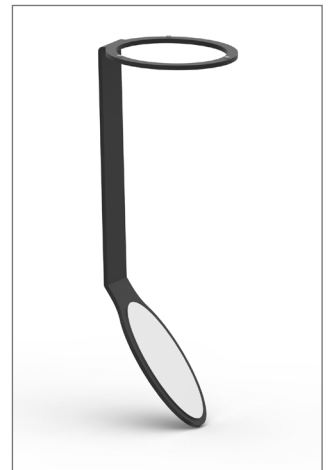
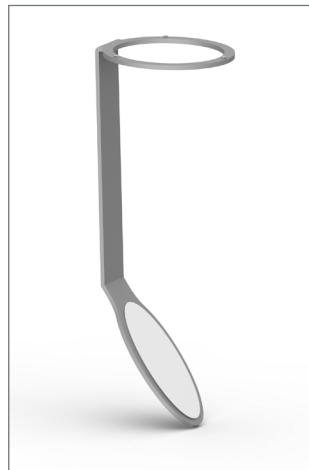

PHOS downlight Deflection Mirror

This special deflection mirror is used to deflect the projected image onto a wall. The mirror holder is magnetically attached to PHOS downlight and can be freely rotated to adjust the projection.

Construction

material:.....aluminium, powder coated, mirror glass
weight: 113 g | 0.25 lbs
compatible projection lens:..... Standard Lens, f=85 mm

Item No.: 01024510 (white), 01024520 (black), 01024530 (silver)

PHOS 45 downlight – Photometric Diagrams

PHOS 45, Extra Wide Angle Lens, f = 45 mm, 48°

illuminance [lux]

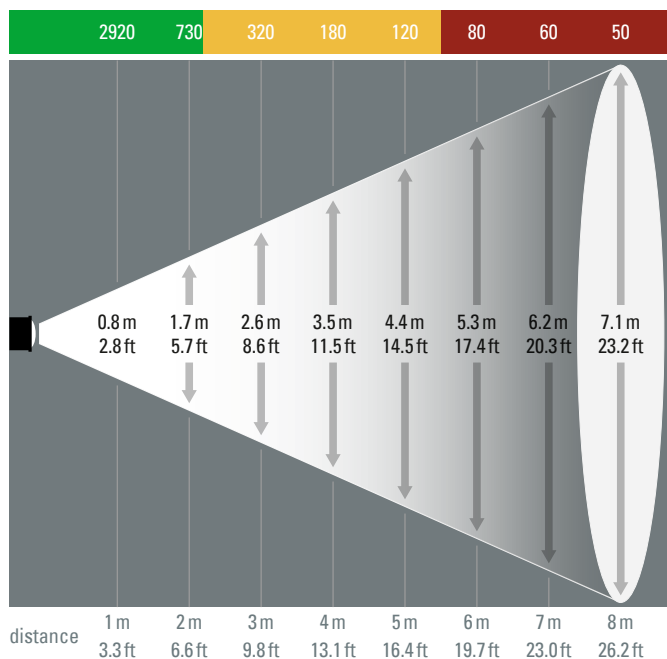

PHOS 45, Wide Angle Lens, f = 63 mm, 35°

illuminance [lux]

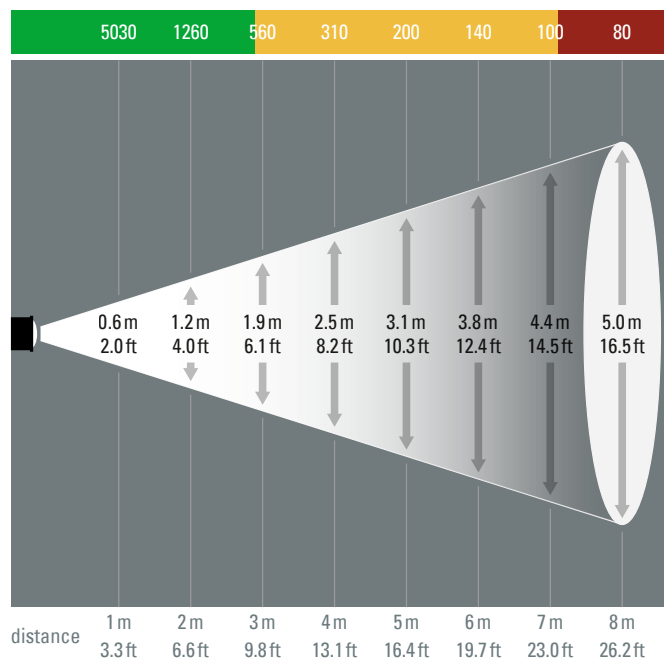

PHOS 45, Standard Lens, f = 85 mm, 26°

illuminance [lux]

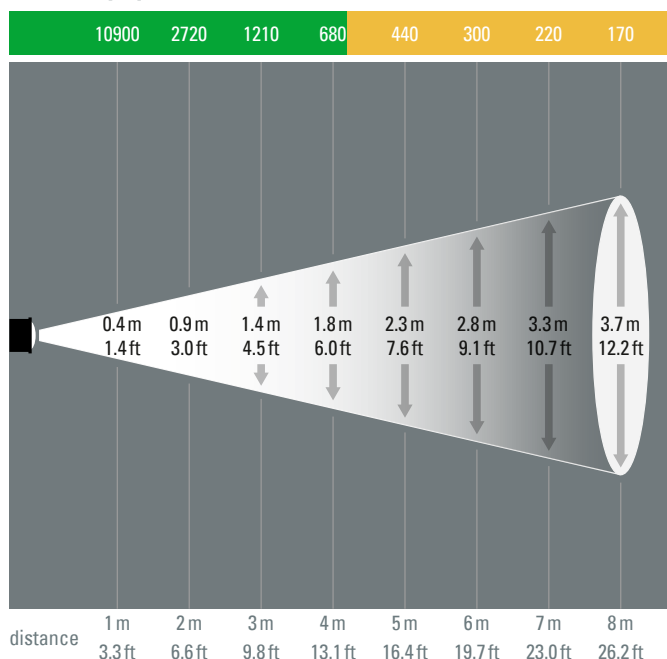

PHOS 45, Telephoto Lens, f = 135 mm, 17°

illuminance [lux]

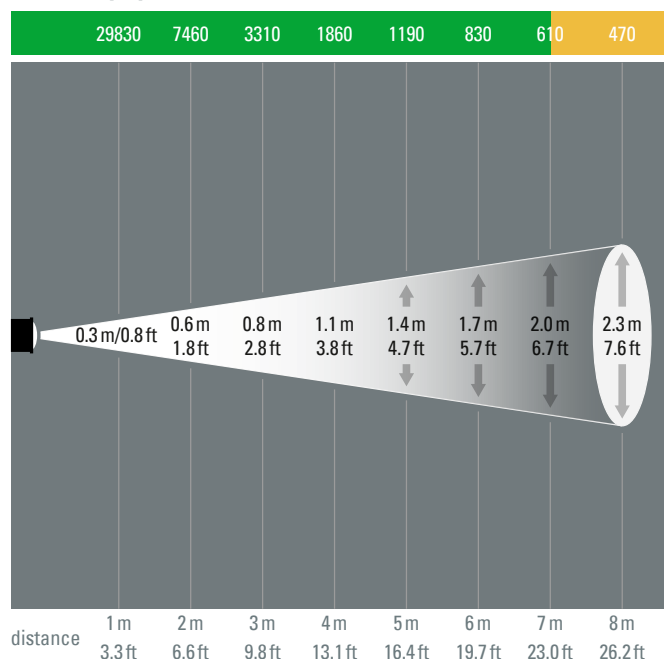

Brightness Colour Coding:

- = with standard room lighting, suitable for coloured motifs
- = in low-light rooms, for motifs without colour
- = recommended only in darkened rooms

- The results shown are approximate values. The result may differ slightly in reality.
- The projection sizes indicate the maximum diameter that can be projected with a Ø 40 mm image.
- The projection motif is circular and fills the image area of the gobo. Other objects, e.g. rectangles or texts are fitted into the circular projection area.
- The projection is at right angles to the projection surface.

Detailed projection calculator at: www.derksen.de

derksen®
lichttechnik

Derksen Lichttechnik GmbH
Johannes-Rau-Allee 4
45889 Gelsenkirchen
Germany

Tel.: +49 209 98070-0
info@derksen.de
www.derksen.de